



*High Performance, Reliability, Security, Intercom for PA Systems*

## Network LAN speaker for Paging and Communication

AD630 IP SIP horn is part of a series of TEMA speakers to be connected in a LAN for the PA (Public Address) paging of ads, speech and music, in offices, factories, public places and outdoor. The internal circuits incorporate a PoE power supply (Power over Ethernet) for direct power over UTP cable, but also allow input from an external power supply at 230Vac/12-24Vdc. The two power supply types can coexist in order to increase the safety of the service.

The devices are also two-way communication systems because they incorporate a microphone with the dual local listening function and control of the speaker functionality. AD630 is a bidirectional communication system with built-in microphone with local listening function and speaker-control functionality.

### Power Amplifier Technology

A high efficiency and low consumption double D-class Amplifier can generate a maximum output power of 40W (2x20W) 8 ohms with high sound quality. The amplifier is self-protected against overload and short circuit output power. It is provided a second auxiliary output which can be brought to another passive speaker to better distribute the output power or to generate a 100V-20W PA line.

### Pre-recorded messages

In the internal SD card are recorded sounds and messages for automatic or command sending onto speaker, also automatically at pre-set times.

### iOS and Android APP

Free download APP are available for smartphones with operating systems iOS and Android. With these applications it is possible to operate with the IP speakers and launch announcements even from smartphones.



### Integration with VoIP SIP phone systems

AD630 can be perfectly integrated with VoIP telephone systems (IP-PBX) with SIP protocol and can be registered as a regular VoIP phone or P2P (Peer to Peer) without a PBX.

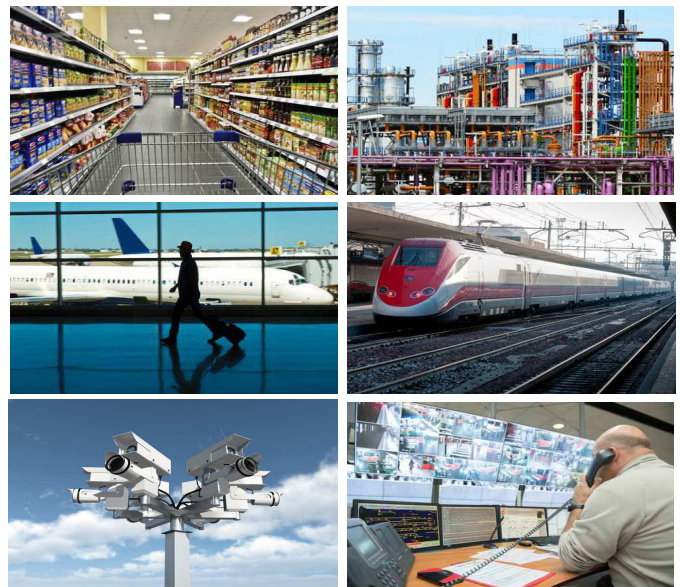

### Applications, Target

- ◆ Video surveillance: warning deterrence to malicious people under video control area
- ◆ Companies, Offices, Factories, Warehouses, Industry
- ◆ Warehouses, Garage, Supermarket, Parking
- ◆ Outdoor public areas
- ◆ Alarm and warning systems
- ◆ Hospitals, Schools, Railway Stations, Airports, Ports

**Innovative features and performances**

- Launch of PA ads from any phone by calling the account of the IP SIP Speaker
- Security code from keyboard to start the announcement
- 2nd SIP accounts night call repeater function, sounds files freely customizable
- Output for 2nd passive speaker 20W 8 Ohm to extend the served area or to generate a 100V-20W audio line
- Double internal audio amplifier 2x20W (maximum output power using external power supply)
- PoE (Power over Ethernet) 802.af standard, only one cable connection
- 2 internal relays for external devices drives via LAN
- 16 Multicast channels for broadcasting background music, silenced by ads, also in high quality (Linear Codec 44,1kHz)
- Volumes adjustable separately for all audio channels Multicast/Ads/Ringtone

- Internal microphone for environment listening (Monitor) and normal bidirectional communication
- 1 alarm trigger input for one of the alternate functions:
  - a) Generate a phone call and sends a message of alert (SIP SECURITY INFO CALL)
  - b) Pre-recorded announcements launch from the speaker (Notice/Deterrence)
  - c) "Push to Talk" feature for phone communication driven by local external button (not included)
- 2 inputs for external call buttons to 2 programmable SIP numbers or IP addresses
- LAN P2P (Peer to Peer) operation even without PBX
- Remote programming via integrated LAN Web Server
- Compatible with all SIP standard IP-PBXs on the market
- IP65 grade of protection

**Technical Features**

LAN, protocols:	TCP/IP Network 10/100BaseTx, SIP 2.0
Grade of protection:	IP65
Power Supply:	PoE, Injector PoE or ext power supply
PoE:	802.3af class 0 12,95W
External Power Supply (Opt.):	230Vac/12-24Vdc-1-2A
Security:	Password access, activity logs
Inputs from external alarm commands:	1
Inputs for diversified call buttons:	2
Contact rating of the 2 internal relays:	max 30Vdc – 1.5A
Technology:	IMX25 400MHz processor
Memory:	256MB Ram, Micro-SD Flash 2GB
Housing material:	aluminium and Abs
Operating temperature:	from -20° to +55°C
Storage temperature:	from -20° to +65°C
Umidity:	up to 100%
Installation:	wall mount
Dimensions:	Diam. 240x290mm
Weight:	2,1Kg

Audio Amplifier:	40W (Ext. Pwr Supply) Class "D" (10W PoE)
Acoustic unit impedance:	8 Ohm
Audio Bandwidth:	300 – 7000Hz
Acoustic pressure (SPL):	117 dB A (1KHz at 1 meter)
Internal Microphone:	omnidirectional electret 30Hz-18KHz
Multicast Audio Streaming:	G711μ, G711a, G722, L16 16...44 kHz
Audio Communication:	Unidirectional and Bidirectional
Additional speakers:	1 passive speaker 8 Ohm 20W
Messages/Sounds:	pre-recorded into the internal SD
Connection:	SIP Server (IPPBX) or P2P (Peer To Peer)
Smartphone APP:	iOS, Android
Acoustic signaling:	call tones, ads Ding-dong
Visual signaling:	Active call led
Programming:	user-friendly web interface and passwords
Origin:	entirely developed and manufactured in Italy
Warranty:	2 years, possibility of extension (option)
Compatibility:	CE, ROHS

**Tested with the most popular PBX brands:**  
 SIEMENS - AVAYA - ALCATEL – PANASONIC – SAMSUNG - NEC - 3CX  
 LG - WILDIX - AASTRA - ASCOM - NITSUKO - SELTA – PHILIPS  
 ASTERISK BASED SYSTEMS

**Packing List**

- 1 IP VoIP SIP AD630 Horn
- 1 Paper manual
- 1 CD-ROM with complete documentation
- 1 3 mt Patch Cord LAN UTP Cable for pre-installation test functions

**Default Peer to Peer Application**

The application does not require the presence of an IP-PBX and the presence of the on-site 220V network (within 100mt from the switch). Each IP Speaker can be reached by SIP phones that can launch an ad. Speakers power travels on the same UTP cable coming from the PoE switch. Thanks to the integrated microphone in the speakers, you can hear the sound of the zone of the respective speaker. The 2 relays embedded in the speaker can be operated by the IP phone that originated the call to operate accessory services.

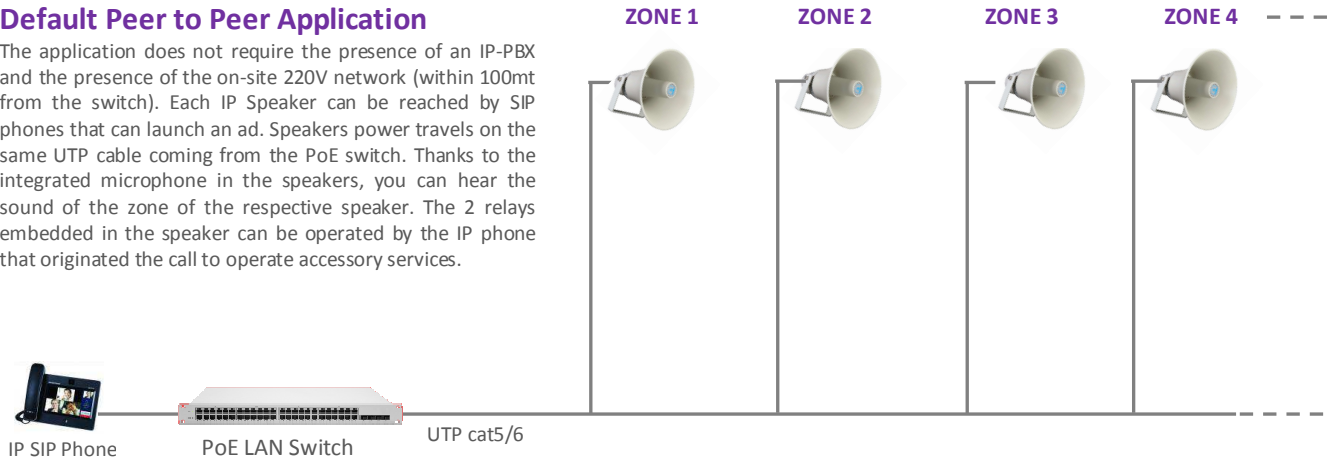

**Application with IP-PBX or Peer to Peer**

Each IP Speaker can be reached from SIP phones, Smartphone and other registered terminals in the IP-PBX that can launch ads. The integrated relay can be operated from the SIP phone that originated the call. With a Network PC with installed the free software TEMA "Videoconsole" it is possible to make calls to IP speakers. If the free software "VLC" is also installed, it will possible to send on Streaming Audio speakers multicast channels, interrupted by ads as background music. In each AD600 series speaker, it is possible to independently adjust the audio volume reproduced via LAN thanks to the integrated web server.

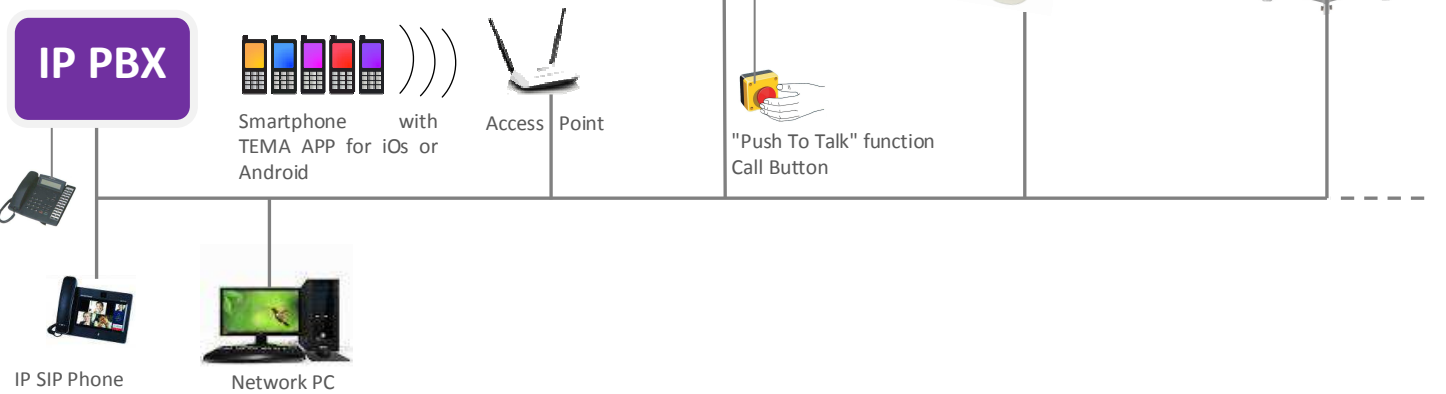

**Audio signal relaunch application**

The application shows how it is possible to serve a zone (Zone 3) that is more than 300 meters since the last IP Horn boosting the audio signal to another amplifier avoiding to extend the LAN network where it is not necessary. The power supply for the IP Horns can be provided by the PoE switch or by local power supply 220Vac/12-24Vdc. The remote amplifier is powered with the local 220Vac/12-24Vdc power supply.

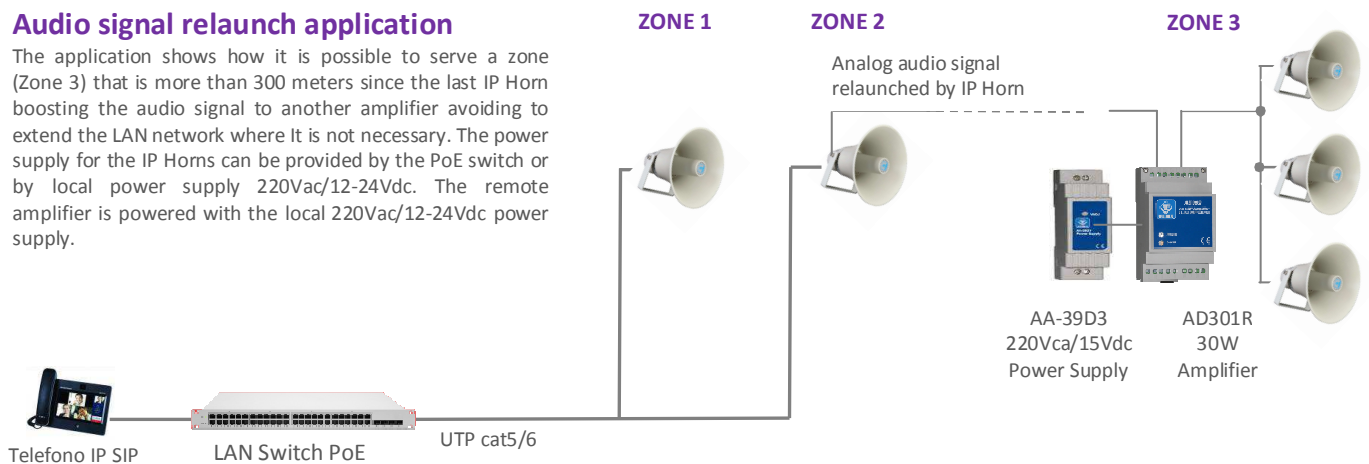

## OPTIONAL ACCESSORIES

**AA-39D1A** DIN Switching Power Supply 220Vca/15Vcc-1,0A

**AA-39E3** DIN Switching Power Supply 220Vca/24Vcc-1,5A

**AA-39E6V** DIN Switching Power Supply 220Vca/24Vcc-2,5A

**AA-39P4** PoE Injector 230Vac/ 48Vdc-12,95W

**AA-36** Power relay repeater 230Vac/16A – 4KW



**AD301A** 30W Audio Amplifier for DIN rail, 2 channels, Volume-High-Low controls +/- 12Db

**AD320/30** DIN transformer 100V-30W audio line

**AD32** Audio signal isolation transformer, ideal for signal relaunch to remote amplifiers

**AD330/xx** Passive speakers 8 Ohm or 100V various power



## DIMENSIONS

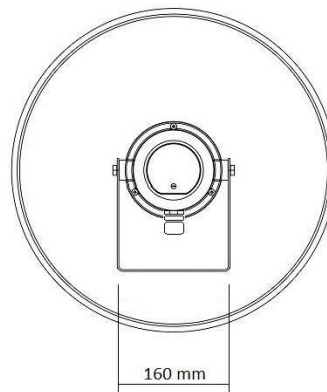
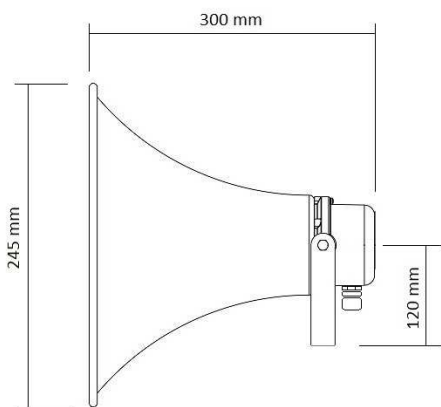

## CABLES INPUT

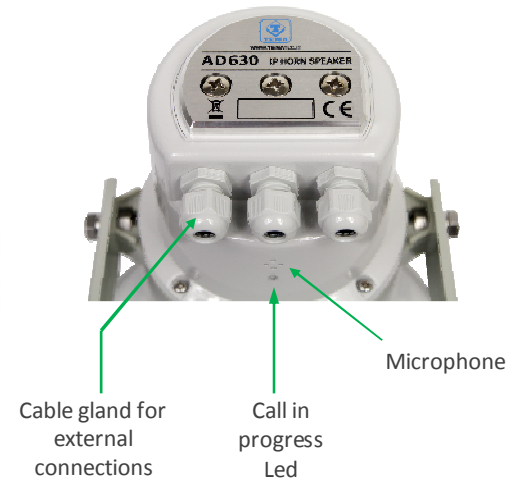

## INTERNAL VIEW

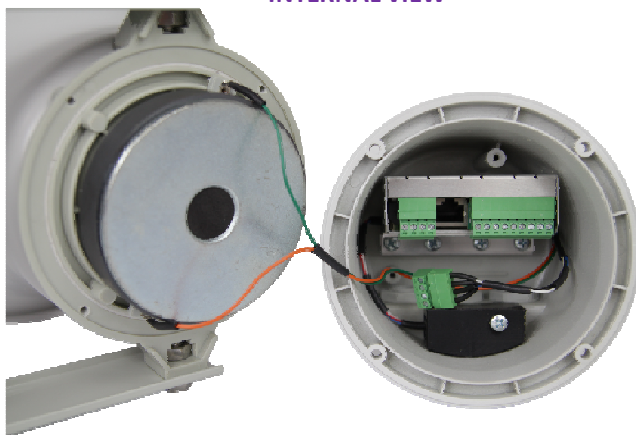

## CONNECTIONS

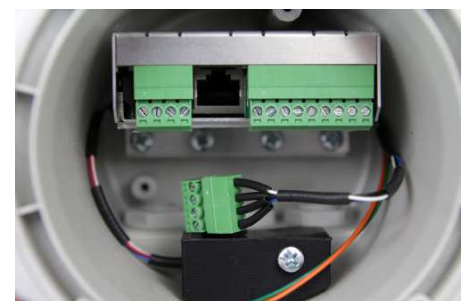

**TEMA TELECOMUNICAZIONI**, founded in 1988 by professionals of the sector, is a leader in the design and manufacture of special systems and services for Fixed and Mobile Telecommunications and Security. The research and development laboratories in Milan, where it is invested more than 15% of sales, are equipped with advanced equipment and skilled personnel in microprocessor technology, hardware-software, programming languages, audio synthesis and Voice-Audio-video processing, LAN technologies, VoIP, Wireless. The company's purpose is to give complete customer satisfaction, continuous improvement of product performance and to offer an excellent technical support service, for that is **UNI EN ISO 9001:2015 quality certified**.

To date TEMA TELECOMUNICAZIONI can claim an installed base of hundreds of thousands of devices and peripherals integrated with protocols of most major brands of PBX and other special systems for Telecommunications and Security.

Operation is ensured at national level through telephone installers and trusted resellers, with technical and commercial support from both the Milan Headquarter office and Rome Branch office. It also organizes regular technical and commercial training courses. The company's revenue is divided between the domestic market and foreign market with exports percentages rising in recent years.

[WWW.TEMATLC.IT](http://WWW.TEMATLC.IT)

"IP COMMUNICATION AND SECURITY COMPANY"



**TEMA TELECOMUNICAZIONI S.r.l.**

Via Costante Girardengo, 1/4 - 20161 Milano MI (Italy) Tel. +39 02 61544.1 Fax +39 02 6152605  
 Web: [www.tematlc.it](http://www.tematlc.it) e-mail: [sales@tematlc.it](mailto:sales@tematlc.it) Tech: [support@tematlc.it](mailto:support@tematlc.it)

